



# USER MANUAL



7" Press



10" Press



20" Press 3 holes  
Filtration capacity: 15 to 50 barrels

## CDL FILTER PRESSES

CDL Maple Sugaring Equipment Inc.

Thank you for choosing a CDL filter press. Our years of experience serving maple producers guarantees that you have acquired an efficient and good quality piece of equipment. Before installing and operating the equipment, make sure you understand all of the instructions in this manual. In addition, if any problem occurs upon receipt of your equipment, immediately contact your local representative or CDL.

## TAKE NOTES

**Take note of the following details for future reference:**

Brand: \_\_\_\_\_

Purchase date: \_\_\_\_\_

Model number: \_\_\_\_\_

Serial number: \_\_\_\_\_

### **Serial Number Location:**

The serial number is located on the press support.



## **IMPORTANT WARNING**

### **Before the first use**

*Prepare a solution of hot soapy water and add the equivalent of one cup of vinegar (250 mL) or 15 mL (1/2 oz.) of acetic acid per gallon (4L) of solution.*

*Hand wash each component (stainless steel pipes, fittings, and valves) that may come in contact with maple sap or maple syrup. Rinse and dry with a soft clean cloth.*

*This will remove any residual traces of manufacturing oil, polishing paste and/or packaging debris.*



## TABLE OF CONTENTS

Take notes	2
Important warning	3
Table of contents	4
Safety	4
Description	5
Press assembly	6
Operating the press	8
Using filter aid	9
The filtration system	10
Quantity of filter aid and flow rate	11
Cleaning the press	12
Filtration capacity	12
20" filter press parts	13
10" filter press parts	14
7" filter press parts	15
Maintenance	16
Troubleshooting	16
The Warranty	17

## SAFETY

Despite appearances, a filter press can be a dangerous piece of equipment. It filters very hot maple syrup. So, when in operation, the plates become very hot. Make sure no-one touches the press when it is hot. Also, before you operate the press, inspect all hoses to ensure that they are in good condition, especially the one between the pump and the plates, as this hose sustains the highest pressure.

If you have to replace a hose, it must be capable of operating at temperatures of at least 230°F and at a pressure of at least 200 psi.

Finally, always check the internal pressure gauge of the press. If the pressure rises above 80 psi, this means it is time to replace the filter papers. If this is not done, it is possible that a hose may burst and hot syrup will spray out. If this happens and someone is close to the press, they may suffer severe burns.



## FILTER PRESS DESCRIPTION

(IMAGE #1)

A filter press is a piece of equipment made to filter liquids. This CDL press is mainly used to filter maple syrup, but it can also be used to filter other liquids such as wine, beer or honey. The plates are made of cast aluminum, a light material with good thermal conductivity. It is essential to filter maple syrup before consumption in order to have a better tasting product without impurities.

Rear plate: The rear plate is attached to the frame of the press. The syrup inlet and outlet are located on this plate.

Filter paper: A sheet of filter paper must be inserted in between each plate of the press. These are the sheets that filter the maple syrup. If the papers have a tendency to tear, it is recommended to put two filter papers between each plate.

Hollow plates: When the press is assembled, the hollow and full plates must alternate. Hollow plates allow the entry of the syrup into the press and keep within the filtration residue and filter aid.

Full plates: These plates allow the syrup to exit the press. The holes located on one of the inner corners of each plate must not become clogged, otherwise the syrup will remain trapped in the press.

Front plate: This plate must be installed after a hollow plate. Each plate must be tightened firmly using the two wing nuts.

**NOTE: The thickness of the hollow plate is important. The thicker it is, the more filter aid that will accumulate inside, therefore it will be possible to filter more syrup before changing the filter papers.**



## PRESS ASSEMBLY

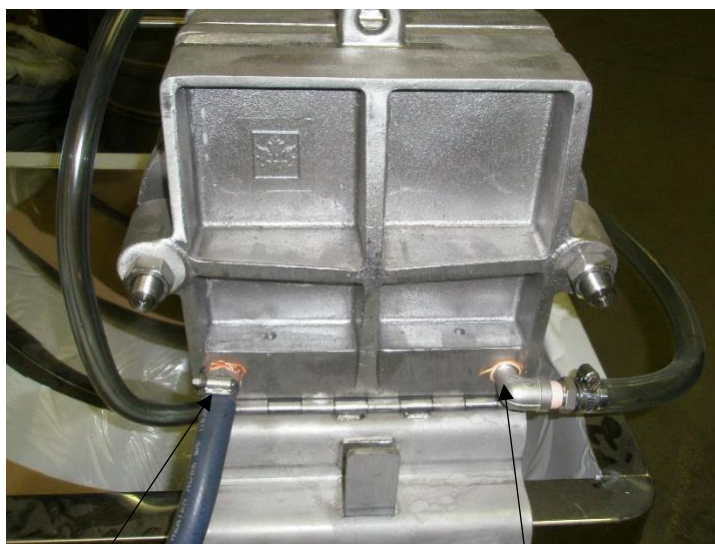
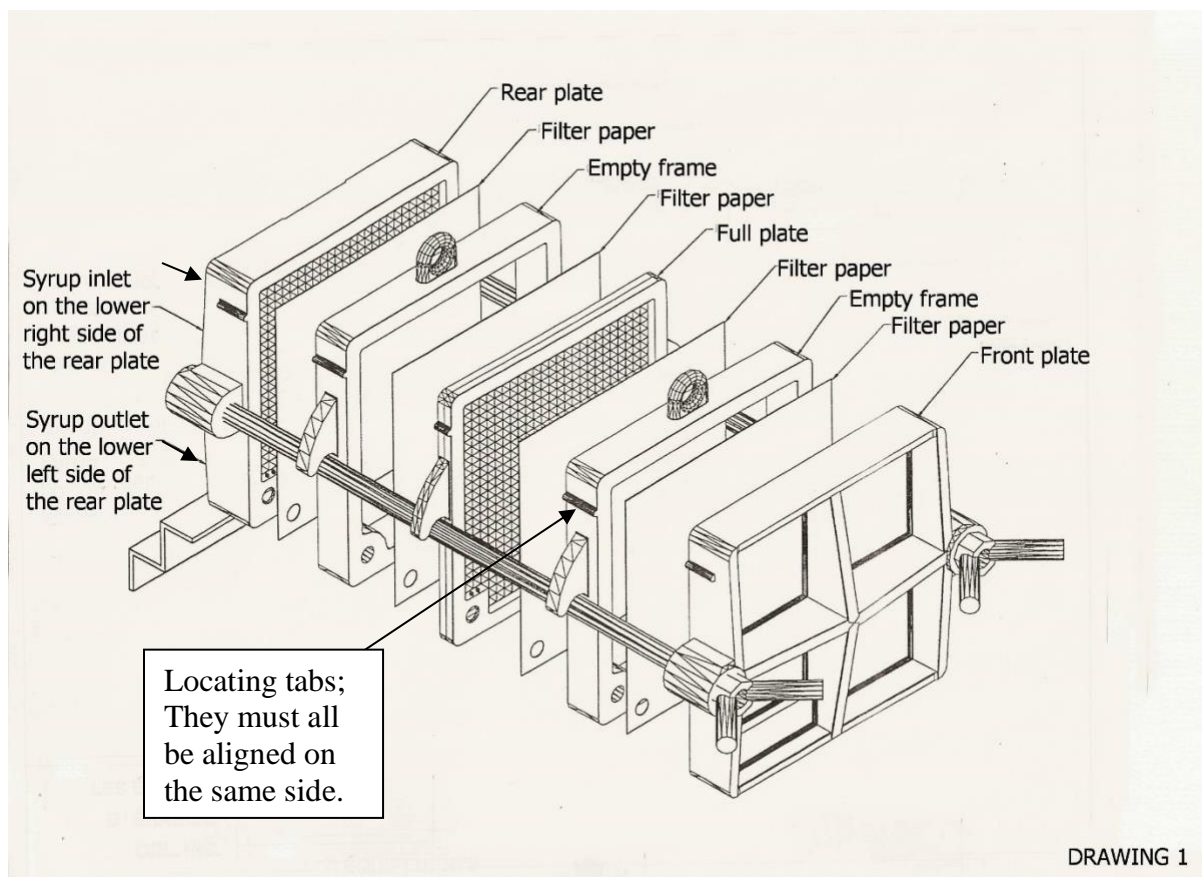

**Syrup inlet (from the pump)**

**Syrup outlet (to the container or barrel)**



## PRESS ASSEMBLY

(Image #2)

Insert the 3/8" metal rods in the two threaded holes situated at the bottom of the rear plate.

Install the press in the order shown in Figure # 1. **Note that all the locating tabs must be on the left side (Figure # 2).**

Before inserting the front plate, remove the mounting rods.

Insert the front plate taking care to place the filter paper against it.

Tighten the plates together using the winged nuts. **Note that during the filtration process, the press will become hot. Once hot, stop the press and re-tighten the nuts.**

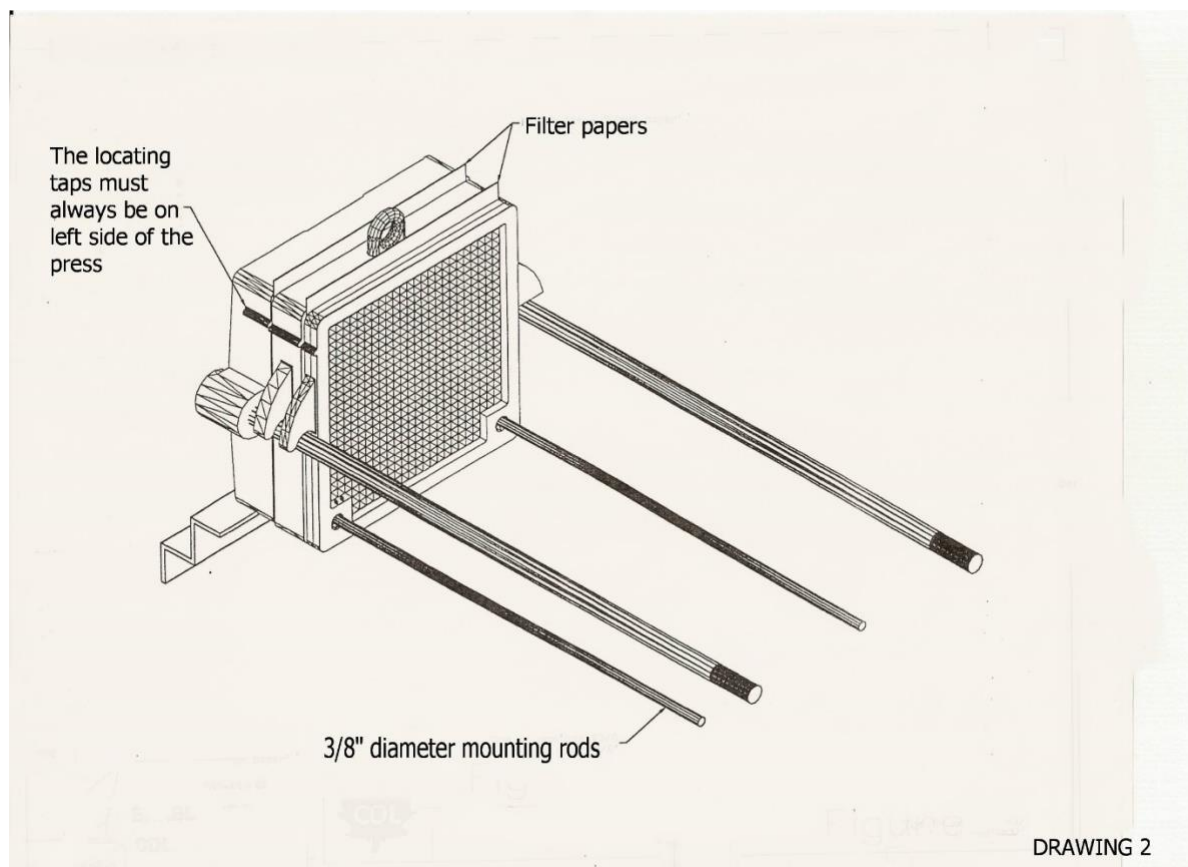

## OPERATING THE PRESS

Put 4 cups of diatomite powder in 12 litres (3 gallons) of hot water and mix well to avoid lumps.

Start the pump and run the entire mixture in the press and ensure that the return water is clear. Throw away the water. If the water exiting the press is blurred, the press is not properly assembled.

**IMPORTANT: never run the gear pump dry, it will wear out quickly.**

When there is enough syrup in the draw-off tank, incorporate the filter aid into the syrup.

Start the pump and drain the water from the press with hot syrup, to minimize loss you can send the output to the big water pan of the evaporator.

Once the water is evacuated, the syrup can be put into the barrels. **Note that you must check the clarity of the syrup before pouring it into a barrel.**

Always filter syrup rapidly once it leaves the evaporator. Maple syrup must be filtered and bottled at at least 185°F. Bottling syrup at a lower temperature could cause the fermentation of the syrup after some time.

Continue filtering until all of the syrup is filtered or when the pressure reaches 80 psi. If the pressure reaches this level, stop the pump, clean the press and replace the filter papers.

Re-assemble the press and resume filtration by following the same procedure.

Occasionally add some filter aid into the filter tank. In general, add 1 cup per 5 gallons of syrup. The amount of powder needed will vary depending on the quality of the syrup.





## USING FILTER AID

In general, diatomite (filter aid) contains multiple particles of various shapes giving a tortuous passage for trapping particulate matter. There are several grades of filter aid, each meeting the specific criteria of each application.

Diatomite is made of plankton fossils that lived millions of years ago and which are deposited on the ocean floor. Mainly composed of silica, it is one of the most abundant minerals on the surface of the Earth. Diatomite is odorless, non-toxic and food grade.

### THEORY OF FILTRATION

Filtering with filter aid is a two step operation. First, a thin protective layer of powder, called the pre-coat, accumulates on the filter paper in a flowing mixture of liquid and powder. Thereafter regularly add small amounts of the powder to the liquid that's to be filtered. As the filtration progresses, the powder mixed with the suspended solids in the unfiltered liquid is deposited on the pre-coat layer, continuously forming, a new filtering surface. The tiny particles of filter aid provide countless microscopic channels that trap suspended impurities, while allowing the liquid to pass through without clogging.

An efficient and economical filter aid must:

- 1) have many porous and rigid particle forms.
- 2) form a highly permeable block, stable and incompressible.
- 3) remove the finer solid particles at high speed.
- 4) be chemically inert and insoluble in the liquid that needs to be filtered.



Diatomite satisfies each criteria



## THE FILTRATION SYSTEM

The essential parts of the filtration system with diatomite is composed of a filter press, a feed pump, a tank containing the liquid to be filtered and the filter aid. The continuous addition of filter aid is normally done manually by adding the powder into the liquid to be filtered. Although, the pre-coat should be introduced into the press by mixing the powder with the already filtered liquid or hot water. This operation continues until all the filter papers are covered with a layer of powder. Thereafter, filtration starts with a minimum of pressure fluctuation.

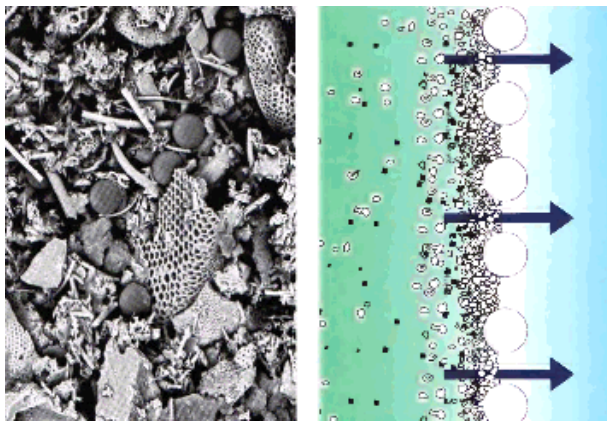

## PRE-COATING

The first step in the use of filter aid is to construct the pre-coat on the filter papers. The purpose of the pre-coat is:

1. To prevent the filter paper from clogging up front.
2. To extend the duration of the filtration between paper changes.
3. To obtain from the start perfectly filtered liquid.
4. To facilitate cleaning of the plates at the end of a filtration cycle.

The pre-coat is obtained by circulating the filtered liquid or hot water mixed with the filter aid into the press. As the powder particles are smaller than the holes in the solid plates, the powder prevents impurities from passing. Air bubbles, pressure changes or vibration can open a passage, prevent effective filtration and cause a hazy liquid, unless the problem is corrected.

## QUANTITY OF FILTER AID

The amount of filter aid required for the pre-coat is 1 to 2 pounds of powder per 10 ft<sup>2</sup> per filter surface to filter, the greater value is required if the press does not distribute well the liquid flow. If it is perfectly distributed, 10lb (4.5 kg) of filtering powder for 100 ft<sup>2</sup> (9.29 m<sup>2</sup>) of filtration area will give a pre-coat of approximately 1/16" (1.6 mm) thick. The concentration of filter aid for the pre-coat depends mainly on the ratio of the amount of liquid to pass vs. the press filtration area. If the concentration is less than 0.3%, it will be difficult to get good results. The formation of an effective pre-coat depends largely on the cumulative effect of the filter aid on the paper.

Surface of a plate of 7": 0.34 ft<sup>2</sup>

Surface of a plate of 10": 0.69 ft<sup>2</sup>

Surface of a plate of 20": 2.78 ft<sup>2</sup>

Example:

A 10" press with 6 solid sheets gives 4.17 ft<sup>2</sup>, so you must put about  $\frac{3}{4}$  lb of filter aid.

One cup of filter aid = 0.259 lb

$\frac{3}{4}$  divided by 0.259 = 2.8957 so put 3 cup of filter aid.

## FLOW RATE

The liquid flow rate of the pre-coat depends on the viscosity of the liquid used. The flow should be sufficient to keep the filter aid suspended, but not too high to penetrate the paper or remove the pre-coat by erosion. For water, a typical flow rate is 1 to 2 gal per ft<sup>2</sup> of filter surface per minute (gsfm) or 40-80 liters per m<sup>2</sup> of filter surface per minute. For viscous liquids, the rate may be as low as 5 gallons per ft<sup>2</sup> per hour (gsfh), or 20 liters per m<sup>2</sup> per hour. In general, put the pre-coat into place at a rate that gives a pressure of about 2 psi (13.8 kilopascals).

The pre-coat liquid should clarify within 2 to 5 minutes. Although, it does not mean that the entire pre-coat is in place, continue a little longer before starting the filtration process. If the liquid in the pre-coat does not clarify, the flow rate may be too high, there may not be enough powder in the liquid, a paper may be pierced, a plate could be damaged.



## CLEANING THE PRESS

When all the syrup is filtered, stop the pump.

Fill the filter tank with hot water.

Start the pump to push the remaining syrup into the press until water starts coming out of the press. (You can also put out the exit hose in the water pan of your evaporator).

Remove the hose from the barrel or container of syrup and put in the floor drain.

Restart the pump and empty the filter tank.

Dis-assemble the press and throw away the filter papers. Clean each plate with hot water. Be careful to not get any water on the electric motor of the pump.

Re-assemble the press as in image #1 to be ready to filter again.

## FILTRATION CAPACITY

7" press: 0.2 to 0.4 barrels (32 imperial gallons) per plate, maximum 2000 taps for a standard press.

10" press: 0.4 to 0.75 barrels per plate, maximum 4000 taps for a standard press

20" press: 1.5 to 3 barrels per plate, pour 15000 taps or more.

**Note:** These numbers are approximate. Several factors affect the performance of a filter press (syrup temperature, syrup quality, quantity of stone, etc.)



## 20" SYRUP PRESS

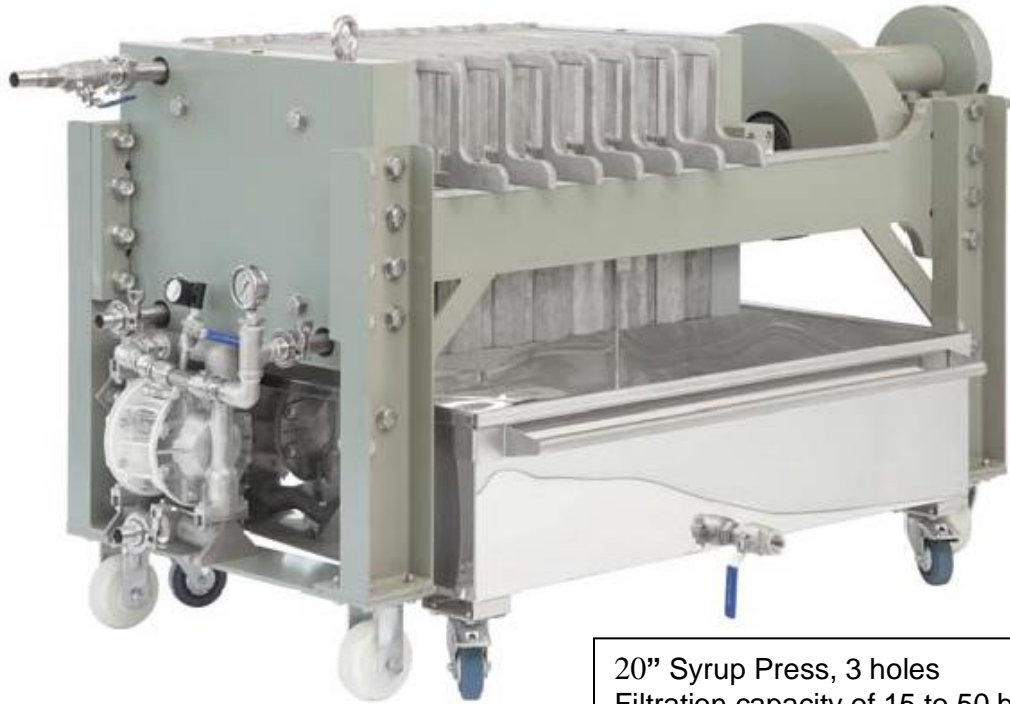

20" Syrup Press, 3 holes  
Filtration capacity of 15 to 50 barrels



# CDL 10" FILTER PRESS

Note: the model may seem different, but the part numbers are the same.

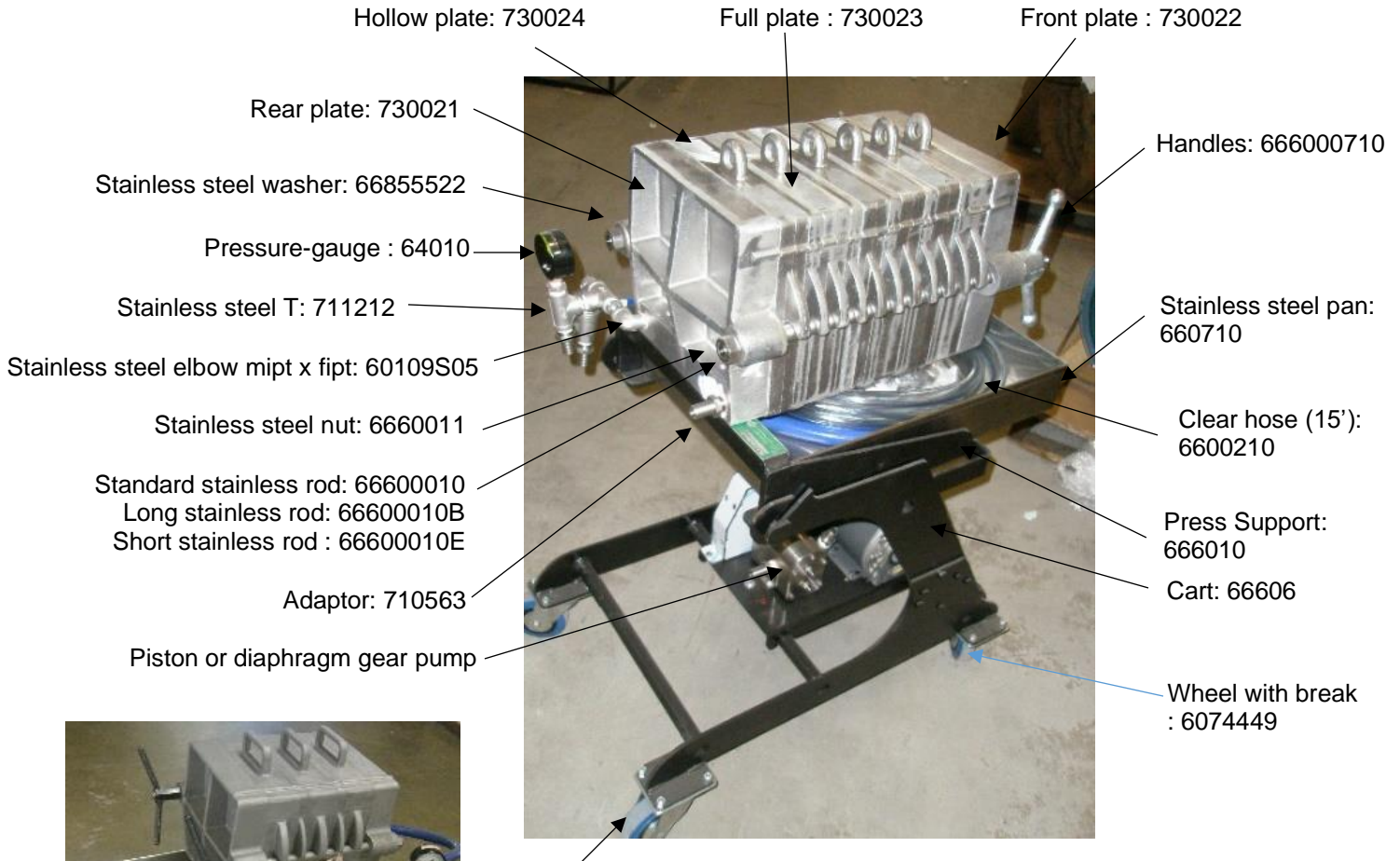

Pivoting wheels: 6072449

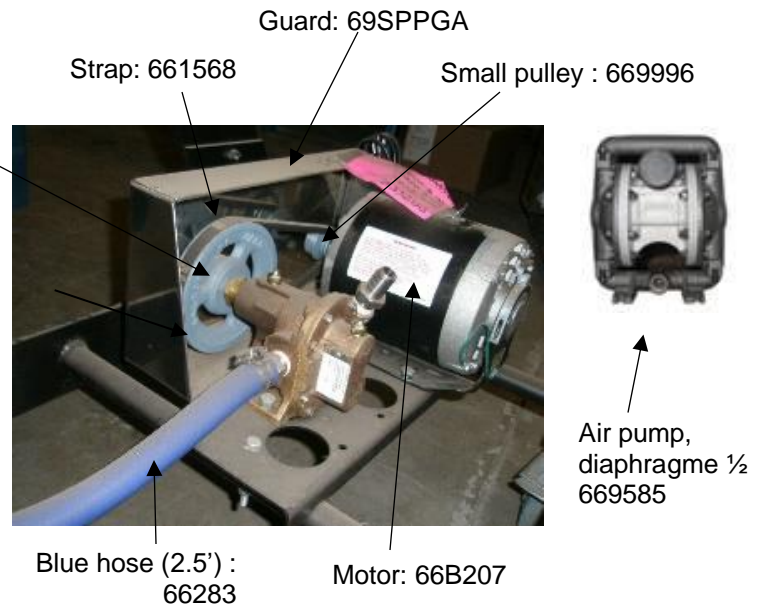

Guiding rods: 660906

Stainless elbow: 6601040

Clear hose (15'): 6600210



# CDL 7" FILTER PRESS

CDL recommended 1/2" diaphragm pump :669585

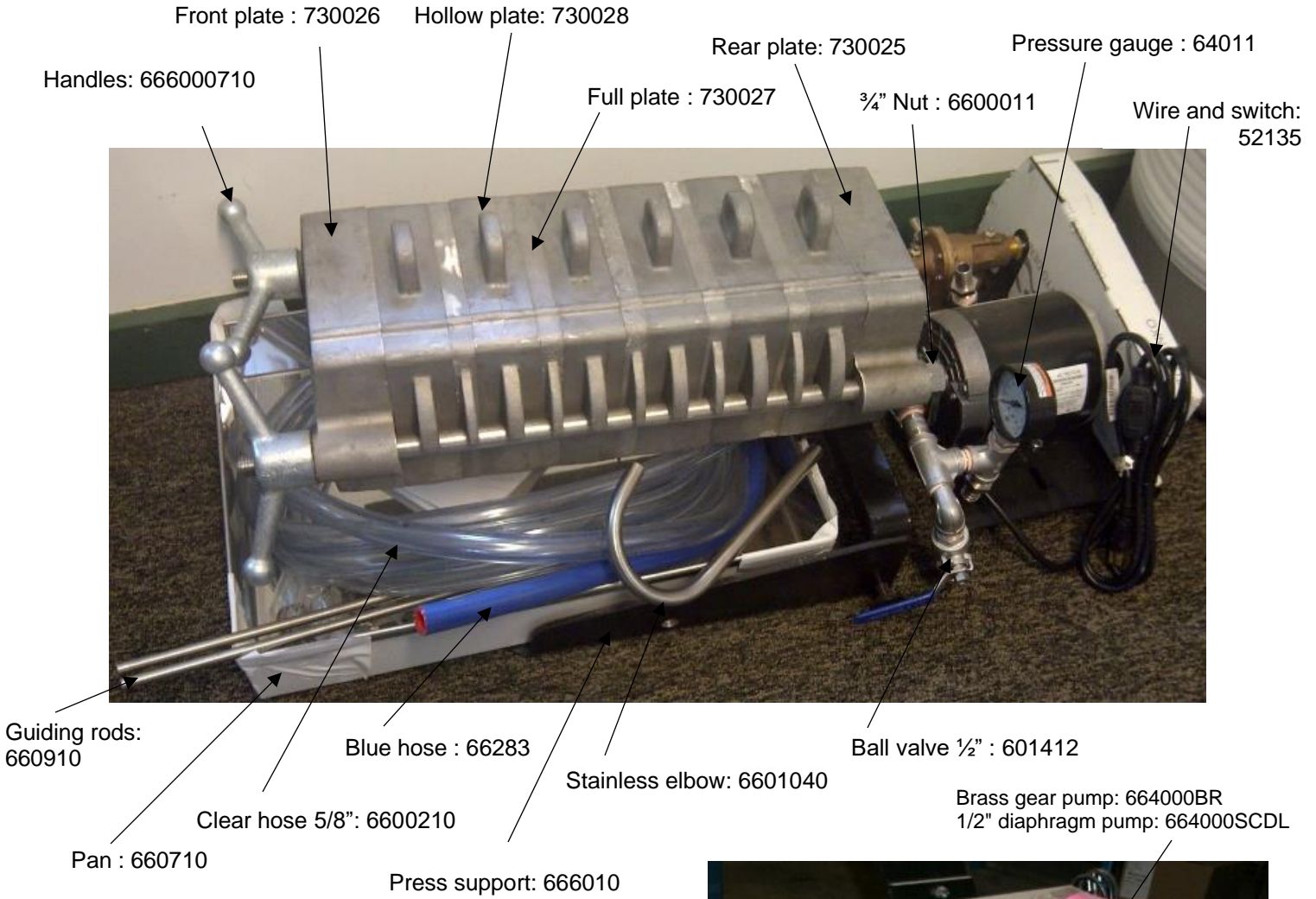

CDL recommended diaphragm air pump

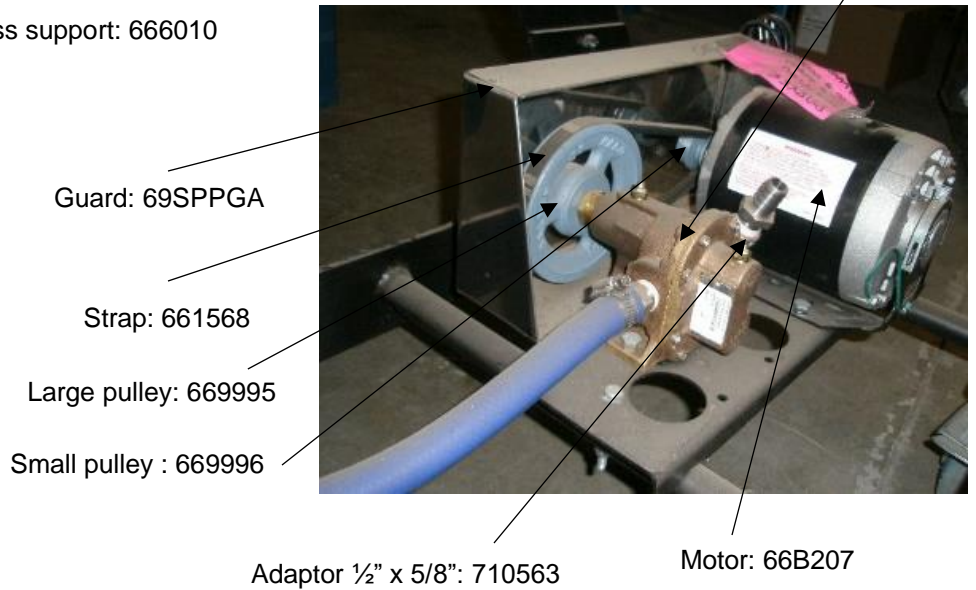

## MAINTENANCE

Periodically lubricate the threads of the plate support rods.

The only other maintenance required is to keep the press clean by washing it after each use with hot water.

## TROUBLESHOOTING

### Problem

### Solution

They syrup is foggy:

- The plates are not well assembled, check that all the indicators are aligned on the same side.
- A filter paper is punctured, replace the papers. (Replace all the papers because it is very difficult to find where the problem lies)- Not enough powder, add powder.

The papers constantly pierce:

- The plates are not well assembled, verify the plates.
- One of the plates has a cutting edge, verify the plates and file them as needed.

The press won't filter anymore:

- Verify the pressure, if it is over 60 psi, replace the filter papers.
- If the pressure is normal, pump problem, repair or replace the pump.





## THE WARRANTY

Your filter press is covered by a limited two-year warranty. For two years from the original date of purchase, CDL Maple Sugaring Equipment Inc. will repair or replace parts of this equipment that are defective in material or workmanship, if this equipment has been installed, operated and maintained according to the instructions provided.

### Exclusions

This warranty does not cover the following:

1. Products with the original serial numbers removed, altered or that are not easily readable.
2. Equipment that changed owners or that is outside of North America.
3. If the damage was caused because the press was kept in a place where the temperature goes below freezing point.
4. If the CDL maintenance procedure was not respected.
5. If the machine was started dry (without liquid inside)
6. Production losses due to problems with the press.
7. Revenue losses caused by the quality of the sap or the syrup.
8. Service calls which do not involve a malfunction, manufacturing defects or defects in material or products that are not used in accordance with the instructions provided.
9. Service calls to correct the installation of your press or for instructions regarding the use of the press.
10. Service calls after 2 years.
11. Damages caused by: services performed by unauthorized service companies; use of parts other than genuine CDL parts or the use of parts that have not been obtained through an authorized technician; or external causes such as abuse, misuse, accidents, fires, or natural disasters.
12. Consumption products such as filter aid and accessories.
13. If the press has been damaged by misuse, negligence, modifications made by the customer or electrical problems.
14. Damage caused by the use of products which are not intended for use in a filter press or improper use of cleaning products.



### **Warning concerning warranties; Limitations of use**

The only recourse for the customer under this limited warranty is the repair or replacement of the product as described above. Claims based on warranties, including warranties of merchantability or adaptation to a particular use, are limited to the shortest period permitted by law, which cannot be less than two years. CDL Maple Sugaring Equipment Inc. will not be held liable for incidental or consequential damages or material damage. Some states do not allow limitations or exemption for incidental or consequential damages or restriction of guarantees. In this case, this limitation or exclusion may not apply. This written warranty gives you specific legal rights. According to the state or province, it is possible that you have other rights.

### **If you need to call for repair**

Keep your receipt, delivery slip, or any other appropriate payment record to establish the warranty period in case you ever need to call for repair. If a repair is performed, it is in your best interest to obtain and keep all receipts. The service you are entitled to under this warranty must be obtained by contacting CDL at one of the addresses or phone numbers below.

The service for your filter press will be done by CDL in Canada. The characteristics described or illustrated and specifications may be changed without notice.

If you live in Canada, please call:  
call:

CDL Maple Sugaring Equipment  
257 Route 279  
St-Lazare, Québec, Canada  
GOR 3J0  
(418) 883-5158  
[www.cdlinc.ca](http://www.cdlinc.ca)

If you live in the U.S.A., please

CDL St-Albans  
3 Lemnah Drive  
St-Albans, VT  
05478  
(800) 762-5587

