

# **IMPORTANT NOTICE**

Before any use of the SpinSeal Welder, it is important to read carefully and in its entirety the User Manual.

For questions about this manual or this product, contact your CDL representative.

Thank you for purchasing the SpinSeal CDL welder.

MAPLE SUGARING  
EQUIPMENT





Version 1.7  
09/27/2019

# USER MANUAL

# SpinSeal™ WELDER





Thank you for purchasing the **CDL SpinSeal** welder. This document will assist you in the proper use of this product. It will provide you with all the necessary information you need.

## TABLE OF CONTENTS

SAFETY	5
TOOLS	5
PRECAUTIONS	5
VERIFICATION	7
ADJUSTMENT	8
SUMMARY OF ADJUSTMENT	13
WELDING	13
WELDING PROCEDURE FOR PLUG	16
MAINTENANCE AND STORAGE	17
WARRANTY	17
EXCLUSIONS	18
TROUBLESHOOTING	APPENDIX

## PRODUCT DETAILS # 730100

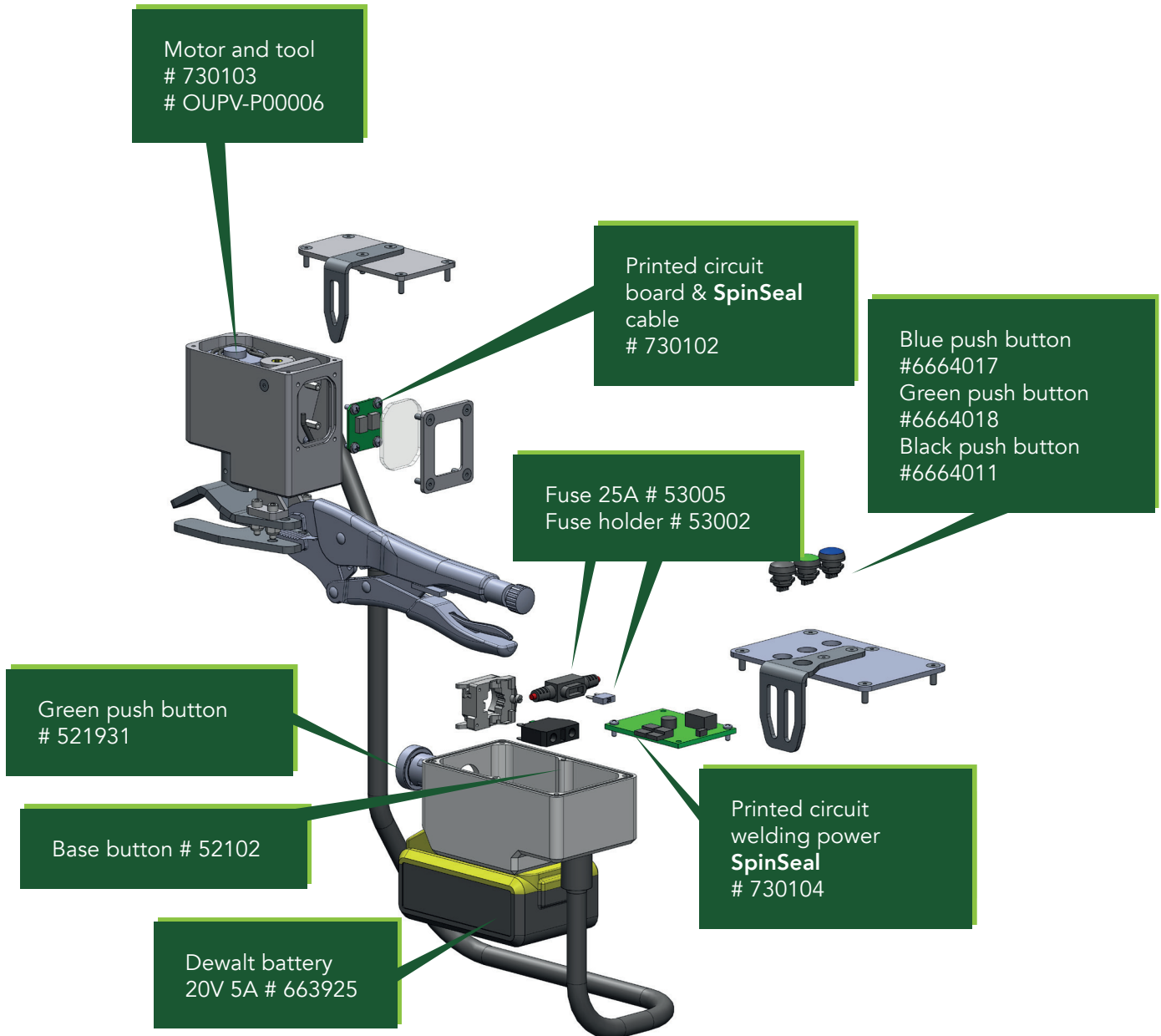



## SPINSEAL DRILLING KIT # 730101

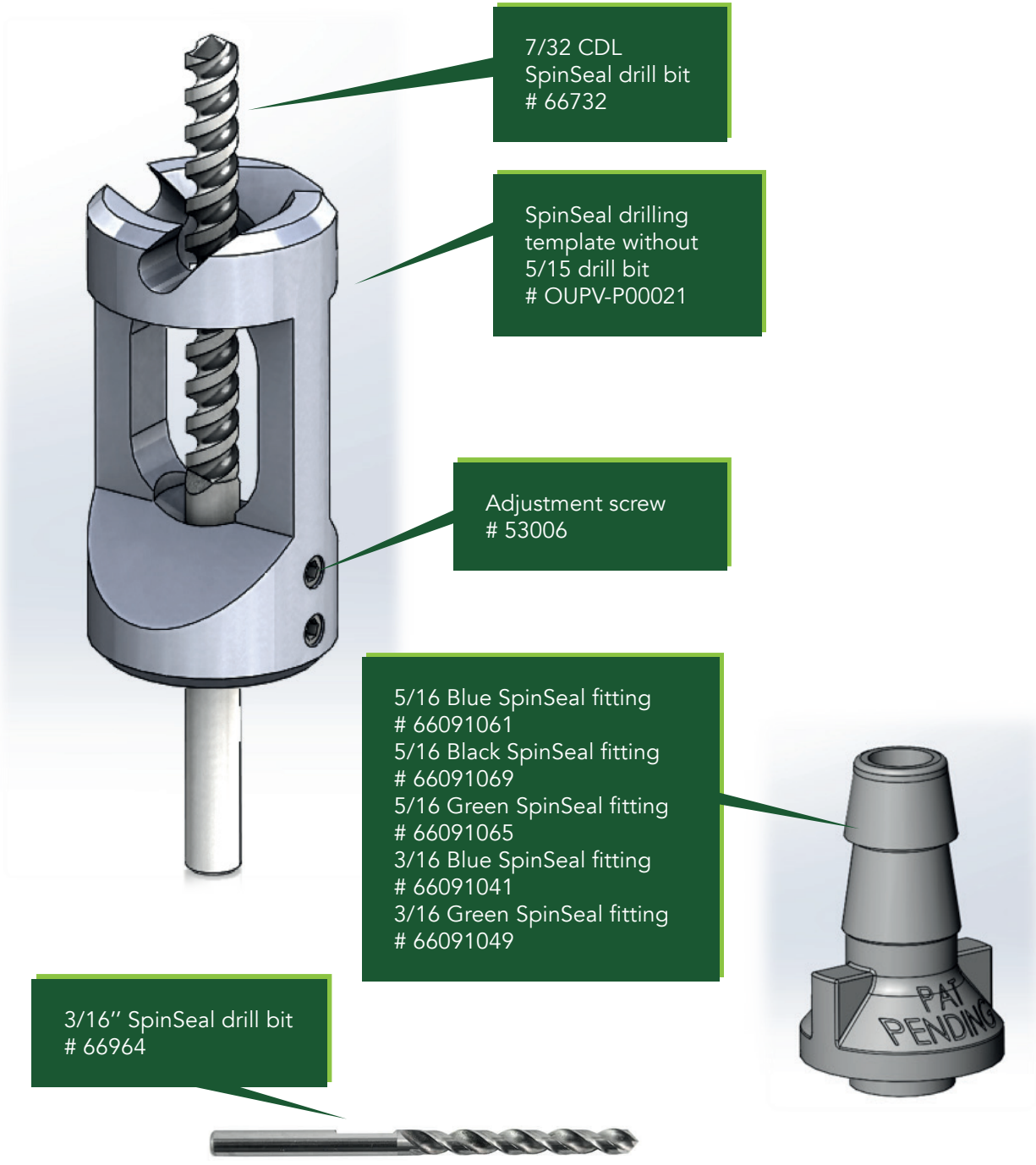



## SAFETY

Before using the welder, it is important to purchase gloves and safety glasses. It is mandatory to wear them at all times when using the welder. Anyone close to the machine while in use should also wear safety glasses. When welding, pieces of hot plastic can be projected, causing burns. **These burning fragments can cause a loss of vision if no protection is used.**

## TOOLS

Before you go out to install your 5/16 fusion fittings on the mainlines, it would be appropriate to bring with you the following items:

- Spray bottle with rubbing alcohol inside
- Clean, dry cloths
- Hexagonal 3/32 wrench
- Cordless Drill
- CDL drill bit with countersinking tool
- Replacement battery(s) Dewalt 20V 5A

The alcohol and cloth will be used to clean the mainline to remove any greasy residue that could alter the fusion of the two plastics. Use only alcohol to clean as it evaporates much faster.

## PRECAUTIONS

It is important to take certain precautions before beginning to install our fittings. **Failing to take these precautions into account could weaken the fusion of the two components and create a BAD WELD.**

- 1) Operating temperature. **Any fusion should be done at a temperature above -10°C (14°F).** Under this temperature, the weld will be weaker. In addition, it is strongly NOT recommended to weld at high temperatures above 30 ° C. It should be noted that any welding with this tool should be done when there is **no precipitation** unless countering the elements with temporary shelters. If there are any precipitations, ensure that the tubing is dry before installing the endings. Rain, snow and ice will create obstacles or contaminants for the fusion of the plastic. **It should be noted that the SpinSeal is not completely waterproof. It is of the customer's responsibility to protect his equipment.**



- 2) Clean surface. Check that the surface of the tubing is **clean and free of contaminants**. If dirt is present, clean the mainline with alcohol and wipe with a clean cloth to remove any residue. Wait until there is no trace of alcohol left before you begin. Any liquid remaining on the surface during the welding will weaken or contaminate the fusion.
- 3) New material. **All fittings must be installed on new equipment only.** A material that has not been worn out by time and weather will guarantee a good fusion of the two components. The place where the fitting is to be laid must be **free of holes**. The design of the **SpinSeal** fitting was conceived to blend perfectly into a uniform tubing. Fastening a fitting to an area where there is a hole could involve a lack of material during the fusion. It is then essential to fuse before drilling.
- 4) Material compatibility. The **SpinSeal** clamp is designed to fit mainlines from 3/4" to 2" diameter. You must also make sure that the 5/16" fittings to be installed are compatible with the mainline.

**Only the HD CDL, CDL Line SpinSeal, Versapipe Fusion and Rapitube Versaprofiles mainlines are compatible.** To find out if your material is compatible, just look at the engravings on the tubing. The type of plastic will also be inscribed.

### Compatibles Mainlines



## VERIFICATION

A quick machine check should be done before each prolonged use.

- 1) Verify that the spring and the sliding guide work properly. Verify that there are no plastic chips that can affect the mechanism. Close the clamp and push the connector insert upwards. The mechanism should slide in a non-jerky manner. The use of «**Fluid film**» lubricant can be used to assist in the operation of the mechanism. **The product «Fluid film» is strongly recommended.**



- 2) When connecting the battery to the SpinSeal, make sure that you hear a beep sound. Confirm that the dial indicates the battery voltage and that the green indicator light is on. If the display shows 17.9 volts or less, the red light will flash and the buzzer will sound, this means it is time to change your battery as it is not charged enough. **It should be noted that a lower voltage would have a major impact on the weld.** This is why the tool is equipped with a system that prevents operation if the voltage is not adequate.



## ADJUSTMENT

A good adjustment of the machine and its settings result in a good fusion . Always follow these steps in sequence when you are about to install a series of fusion fittings or when there is a change in temperature.

### 1) The clamp opening

The clamping pressure of the clamp must be adjusted according to the size of the tubing to be fused.

- (a) Open the clamp and place it in the center of the mainline you are going to weld. Snap the clamp to close it.
- (b) Turn the adjusting screw until the top part and the bottom part of the clamp come into contact with the tubing.

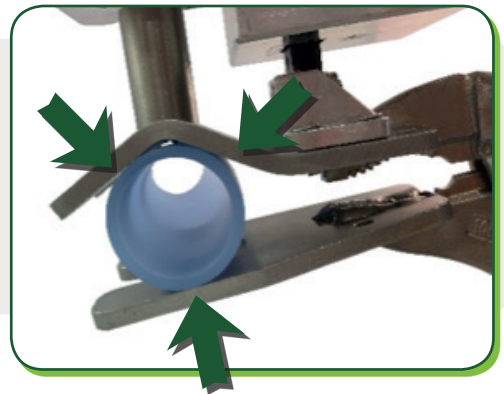
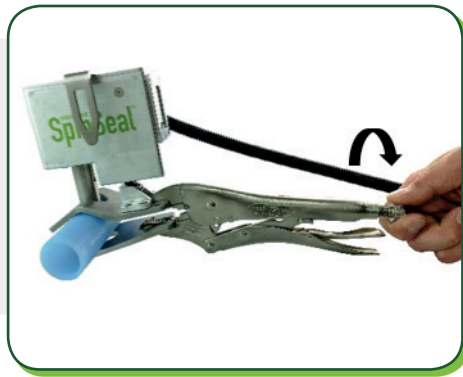

- (c) Open the clamp and turn the adjusting screw a ½ turn for a tight fit.



## 2) Welding time, cooling, mode type

It is essential to adjust the settings before you begin to weld.  
Refer to the table for suggested times.

- (a) Connect the battery to the machine and wait for the green light on the display to light up. The number in red indicates the voltage of the battery. If the voltage indicates 17 (red light on the left flashes + beep sound). You must replace the battery.

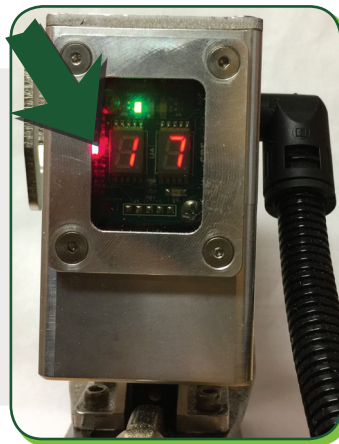

- (b) Hold down the green button on the selector until the green light on the display begins to flash. Release the button. You are now in settings. See the picture below to understand the function of each button.





**(c)** The red and green lights will start flashing. This will tell you that you are in the mode (Fusion Time). Use the black and blue buttons to adjust your welding time to suit your needs. Once selected, press the green button once.



**(d)** The green and blue lights will start blinking. You are now in the mode (cooling pressure time). Use the black and blue buttons again to select your desired time. Press the green button to confirm.



**(e)** The lights (green, red) and blue will start flashing. You are now in (Manual / Automatic) mode. Use the black and blue buttons again to select your mode. Of = Automatic mode and ON = Manual mode. Press the green button to confirm.

**(f)** Your settings are now set.

### 3) Validating your settings

Once your settings are set, an empty test (no fusion connection) can be made before starting. This is the best way to validate if everything works properly.

- (a) Press the (Start cycle) button and make sure everything matches your settings. If you need to stop the **SpinSeal** during the welding cycle, press the start button a second time. The **SpinSeal** will stop automatically. This mode (emergency stop) may be useful if you perceive that your welding time is too long and that you are digging the fitting into the pipe. If you are in (Manual) mode, hold down the button to start the **SpinSeal**. Release to stop the machine.

IMPORTANT: If you make an emergency stop, it is IMPORTANT to remove the pliers from the **SpinSeal** fitting before performing another cycle (cycle start button). It will be impossible for the welder to perform another cycle if the fitting has already had a weld start. This could cause the fuse to break.

- (b) If you are in (Manual) mode the orange light is on. Hold the button to start the **SpinSeal**. Release to stop the **SpinSeal**. the manual mode is used for more complex tasks and repairs.



**Do not press the green button repeatedly as this will overheat the fuse.**

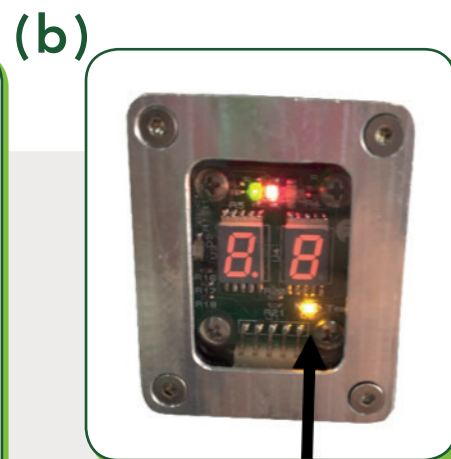

**If the orange light is on, you are in manual mode.**

After five minutes of inactivity, the **SpinSeal** will go into standby mode. The display will turn off and the green light will blink. Press the green button (Enter) to exit standby mode.

#### 4) Drill bit adjustment

The drill bit must be adjusted in relation to the CDL countersinking tool to remove any fusion residue without damaging the mainline.

- (a) Unscrew the two Allen screws to allow the adjustment of the drill bit. Use a 5/64 Allen wrench. Adjust the height so that there is 5/8" (0.625") between the countersinking tool and the beginning of the conical "tapered" part of the drill bit. Tighten the screws on the flat part of the drill bit.

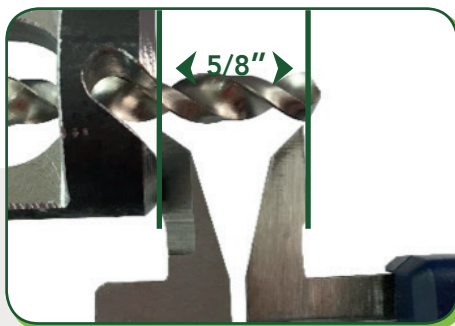

- (b) A fusion fitting can be used to validate the fit of the drill bit. Press the end of the fitting onto the countersinking tool. The reinforcement of the fusion joint should reach the middle of the conical "tapered" part of the drill bit.

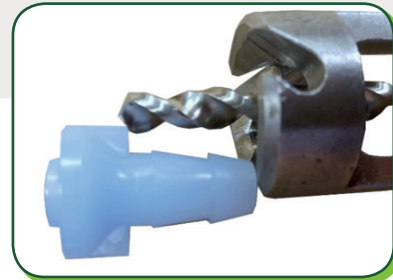

#### Adjustment of drill bit for 3/16" fitting

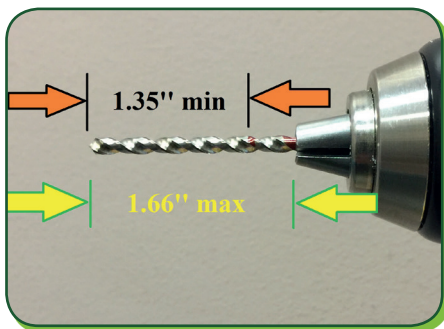

1.35" min. 1.66" max

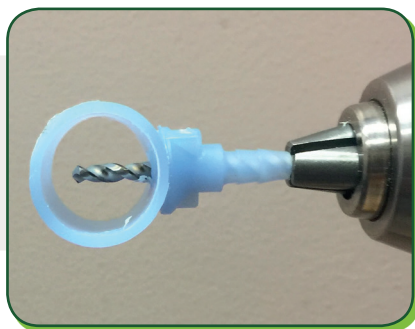

Good adjustment

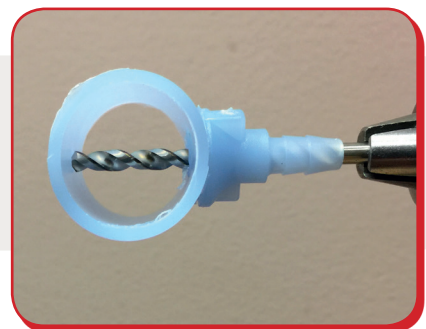

Bad adjustment

## SUMMARY OF ADJUSTMENT

- 1) Opening of the clamp
- 2) Welding time, cooling, mode type
- 3) Validating your settings
- 4) Drill bit adjustment

Strongly recommended

## WELDING

*Once the adjustments are complete, it is now possible to install the fusion fittings. Welding and drilling tests on a piece of mainline, under the same climatic conditions, should be carried out before installing a series of fittings or during any change in temperature.*

This is the best way to ensure that the settings are appropriate. **It is preferable to shut off the vacuum supply before installing the 5/16 end fittings.** If the tubing is under vacuum, small pieces of plastic may be sucked in and taken to the extractor. **It is the user's responsibility to prevent these small residues from damaging his equipment.**

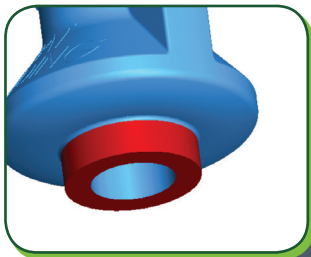

The Spineal fitting as been developed to be weld on pipe by his center. The ring (indicated in red) at the bottom of the fitting is the important part to be melt.



Appearance of the fusion cord

The weld will be completed from the beginning of the appearance of the fusion cord. A bad fusion will be seen by a **lack of liquefaction** of the plastic or a spacing between the two components. If a weld seam is not visible, the settings must be readjusted. On the contrary, a too-fused connection will be perceptible because the tip will tend to «dig» and descend into the tubing. This may cause the fitting to pass through the pipe or create a weakness in the pipe.

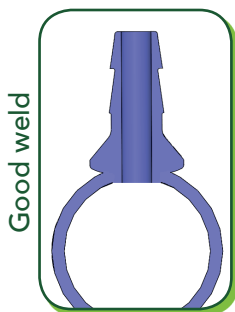

Good weld

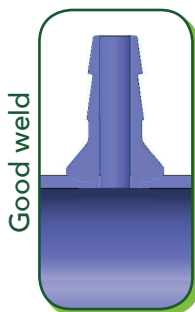

Good weld



Lack of liquefaction



Lack of welding

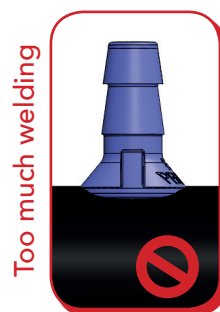

Too much welding

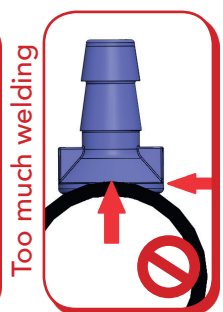

Too much welding

## WELDING PROCEDURE

- 1) Locate the location on the pipe where you want to put a fusion fitting. Always choose a place without holes.
- 2) Make sure that your surface is clean and free of contaminants.
- 3) Place your fusion fitting on the **SpinSeal** in the appropriate place. Push the fitting firmly in place.

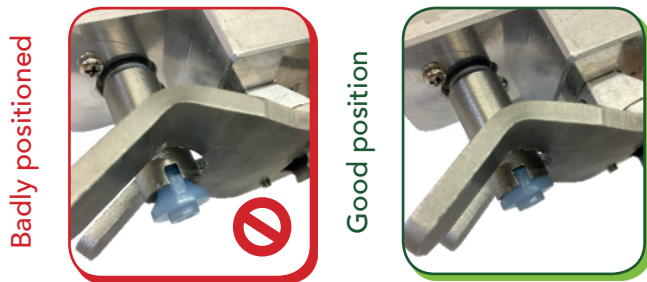

- 4) Put the clamp on the tubing and close it with a slight pressure.

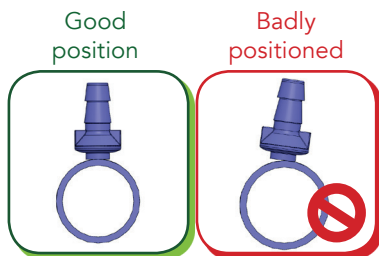
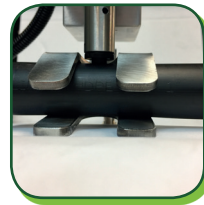

- 5) Validate that your fitting is in contact with the mainline.



- 6) Start the fusion cycle by pressing the button (cycle start), **holding the clamp at all times** to avoid any movement that may affect the weld.

- 7) Wait until the timer has finished and you hear the beep
- 8) Remove the clamp upward and not from the side.

**NOTE:** Once welded, do not apply force to the fitting. Cool for at least 30 minutes.

## DRILLING PROCEDURE

Use the drill with the countersinking tool and the drill bit to remove the hole from the fitting.



- 1) Insert the drill bit 1/2 inch deep in the fitting.
- 2) Orient the drill bit to be perfectly perpendicular to the fitting.



- 3) Operate the drill until the fittings ribs are removed (except 3/16" fittings).

Ribs



**NOTE:** A fitting with no rib will confirm that it has indeed been emptied and that the weld is solid.

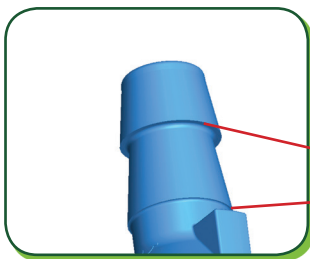

**\* Be careful not to damage the barbs for the 5/16 tubing.**

**BARBS**

**Note:** It is important to use a sharp CDL SpinSeal drill bit. It is designed to expel as many shavings as possible outside of the tubing, to limit the burrs and to make straight and precise holes. Plastic shavings should be regularly removed to ensure uniform drilling and not to damage the subsequent drillings.





## WELDING PROCEDURE FOR PLUG

**Warning :** The SpinSeal plug has been designed to make a last resort repair for 5/16" maximum size holes.

**No warranty is offered due to quality welds, various breakages or production losses.**

**IMPORTANT:** Closing the hole by welding is done manually and visually and requires special attention.

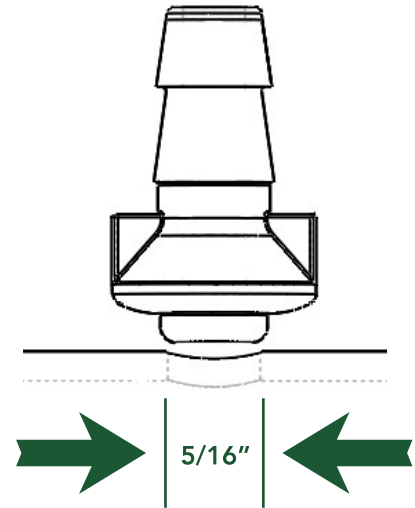

- 1) Program SpinSeal welder in manual mode. **See page 10 (e), 11 (3b)**
- 2) Make sure the surface is clean and free of contaminants.
- 3) Insert SpinSeal plug in place on the SpinSeal welder. Push the plug well and check that it is in place.
- 4) Start welding cycle by pushing and holding start cycle button. Release button only when the hole is completely closed. It is important to hold the clamp at all time in order to avoid any movement that may affect the weld.
- 5) Cooling: When the SpinSeal welder is in manual mode, there is no timer or sound signal for cooling. **Wait at least 15 seconds before removing the clamp.**
- 7) Remove the clamp vertically to not affect the weld.

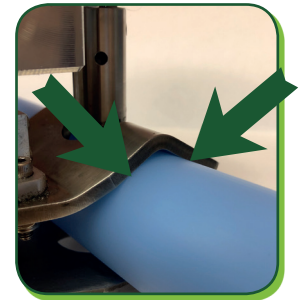

Upper jaw (V shape) is well positioned

**IMPORTANT:** Once welded, do not apply force to the plug.

Grey 5/16"  
SpinSeal plug  
66091059

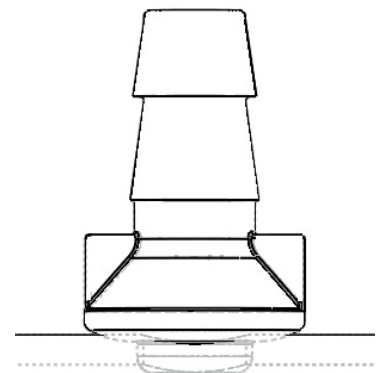

Completed weld



## MAINTENANCE AND STORAGE

After each use of the **SpinSeal**, a cleaning should be done to ensure longevity and proper functioning of the product. Make sure there is no plastic residue on the sliding guide and where the motor. If necessary, use a small brush to remove small shavings. **Make sure the product is dry before putting it back in its storage** case to prevent moisture. It is important to **disconnect the battery to shut the device completely**.

## WARRANTY

The **SpinSeal** has a 1-year machine warranty on parts and labor in the workshop. This warranty includes breakage and manufacturing defects. The product must be used under normal use to be covered. Weld quality, tubing break related to weld and production losses are not covered. It is of the responsibility of the user to validate the fusions that have been made and their sealing.



## EXCLUSIONS

This warranty does not cover the following:

- 1) Products with the original serial numbers removed, altered or that are not easily readable.
- 2) Equipment that changed owners or that is outside of North America.
- 3) If the CDL maintenance procedure is not respected.
- 4) If damage is caused by the Spinseal being kept in a place where the temperature is lower than the freezing point and water or humidity got inside.
- 5) Production losses due to any problem with the **SpinSeal**.
- 6) The loss of income caused by any problem with the **SpinSeal**.
- 7) Service calls that are not related to a malfunction, a manufacturing defect or a defect in material, or for products that are not used in accordance with the instructions provided.
- 8) Service calls to check the installation or to obtain instructions regarding the use of your **SpinSeal**.
- 9) Service calls after 1 year.
- 10) Damage caused by: repairs made by unauthorized technicians; The use of parts other than the original CDL parts or the use of parts that have not been obtained through an authorized technician; Or external causes such as abuse, misuse, accidents, fires or natural disasters.
- 11) If the **SpinSeal** has been damaged by abuse, neglect, alterations made by the customer or electrical problems..
- 12) Damage caused by the use of products not intended for use with a welder or by misuse of cleaning agents.

MAPLE SUGARING  
EQUIPMENT



# APPENDIX - CHART



\*Note that this chart shows starting adjustments, a visual inspection of the weld always remains necessary. Refer to the manual for an example of a good weld. Several factors can influence the welding (external temperature, the external humidity rate. The color and pattern of tubing. The temperature of the tubing itself if it is exposed to the sun or not.) For better stability of operation, it is strongly advised to operate the Spinseal with a battery voltage above 19 volts.

	Welding time (sec.) at 10°C (50°F) or more	Cooling time (sec.)	Welding time (sec.) at 10°C to 0°C (50°F to 32°F)	Cooling time time (sec.)	Welding time at 0°C to -10°C (32°F to 14°F)	Cooling time (sec.)
<b>CDL HD Tubing Blue, Black, Green</b>						
3/4"	2 to 2.5	15	2 to 2.5	15	2 to 2.5	10
1"	2 to 2.5	15	2 to 2.5	15	2.3 to 2.8	10
1 1/4"	2.2 to 2.5	15	2.2 to 2.6	15	2.3 to 2.8	10
1 1/2"	2.2 to 2.5	15	2.2 to 2.6	15	2.5 to 2.8	10
<b>Versapipe Blue and Black Fusion tubing</b>						
3/4"	2 to 2.5	15	2 to 2.5	15	2.2 to 2.5	10
1"	2.2 to 2.5	15	2.2 to 2.5	15	2.4 to 2.7	10
1 1/4"	2.3 to 2.6	15	2.3 to 2.6	15	2.5 to 2.8	10
1 1/2"	2.4 to 2.7	15	2.4 to 2.7	15	2.5 to 2.8	10
2"	2.5 to 2.8	15	2.5 to 2.8	15	2.8 to 3.1	10
<b>Versaprofile Rapitude Blue</b>						
3/4"	2.0 to 2.2	20	2.0 to 2.2	15	2.2 to 2.5	15
1"	2.0 to 2.2	20	2.0 to 2.2	15	2.2 to 2.5	15
<b>CDL Spinseal tubing</b>						
3/4"	2.0 to 2.2	20	2.0 to 2.2	15	2.2 to 2.5	15
1"	2.0 to 2.2	20	2.0 to 2.2	15	2.2 to 2.5	15
1 1/4"	2.2 to 2.5	20	2.2 to 2.5	15	2.3 to 2.5	15
1 1/2"	2.2 to 2.5	20	2.2 to 2.5	15	2.3 to 2.5	15



## TROUBLESHOOTING CHART

Problems	Causes	Solutions
The machine won't start	<ul style="list-style-type: none"> <li>• Battery too low (17.9 V and -) / defective</li> <li>• Defective fuse</li> <li>• Motor temperature too high due to very high outside temperature. (thermal protection of the motor)</li> </ul>	<ul style="list-style-type: none"> <li>• Replace the battery</li> <li>• Replace the fuse</li> <li>• Let the motor cool down</li> </ul>
The unit no longer displays the battery voltage	<ul style="list-style-type: none"> <li>• Standby mode activated</li> <li>• Battery incorrectly connected</li> </ul>	<ul style="list-style-type: none"> <li>• Press the green button (Enter)</li> <li>• Reconnect the battery</li> </ul>
The battery doesn't last long	<ul style="list-style-type: none"> <li>• Battery too old</li> <li>• Battery under 5A</li> </ul>	<ul style="list-style-type: none"> <li>• Change the battery</li> <li>• Use a 5A battery</li> </ul>
The welding cycle does not start by itself	<ul style="list-style-type: none"> <li>• Manual mode on</li> </ul>	<ul style="list-style-type: none"> <li>• Reset to automatic mode</li> </ul>
<ul style="list-style-type: none"> <li>• Difficulty clearing the fusion connection</li> <li>• Plastic residues on tubing</li> </ul>	<ul style="list-style-type: none"> <li>• Used drill bit</li> <li>• Damaged drill bit</li> </ul>	<ul style="list-style-type: none"> <li>• Change the drill bit</li> </ul>
The fitting appears to fuse at the surface of the tubing	<ul style="list-style-type: none"> <li>• Spring mechanism</li> <li>• Welding time too low               <ul style="list-style-type: none"> <li>• Low RPM</li> <li>• Low battery</li> </ul> </li> </ul>	<ul style="list-style-type: none"> <li>• Confirm that the spring system is not blocked</li> <li>• Put some lubricant on the sliding guide</li> <li>• Adjust the welding time               <ul style="list-style-type: none"> <li>• Motor problem</li> <li>• Replace battery</li> </ul> </li> </ul>
The fitting seems to fuse too deep	<ul style="list-style-type: none"> <li>• Check the welding pipe model</li> <li>• Incorrect settings</li> </ul>	<ul style="list-style-type: none"> <li>• Adjust the settings</li> </ul>